



IMAGININGS



Front Cover:  
**Metropolitan State Hospital**  
Norwalk, California

Medium Ironspot #77, Dark Ironspot;  
Modular Brick; Velour Texture



## TABLE OF CONTENTS

Introduction .....	2
Thin Brick .....	3
Tile .....	5
Face Brick .....	7
Residential Brick .....	9
Special Shapes .....	10
Pavers .....	11
Pool Coping .....	13
Brick Murals .....	14



**Lucas Oil Stadium** – Indianapolis, Indiana  
Medium Ironspot #77 (Field), Manganese Ironspot (Accent)  
Thin Brick Precast; 1/2" x 3-5/8" x 7-5/8" (Utility)  
Velour Texture



**Carmel Clay Public Library** – Carmel, Indiana  
Desert Ironspot Light, Desert Ironspot Dark, Manganese Ironspot; Roman, Modular; Velour Texture



**Library** – Tilden, Nebraska  
Hand-Crafted Murals

## IN PARTNERSHIP WITH THE IMAGINATION

Endicott products serve as the building blocks of the imagination. Giving life to ideas, bringing beauty and functionality to form and raising the level of craftsmanship to new heights. A partnership in the truest sense, Endicott enhances the imaginations of great architects and helps them realize their dreams.

The uniqueness, versatility and quality of Endicott products are legendary for their ability to amplify the design and give shape to the vision. Endicott prides itself on providing designers and builders with a product palette unequaled in the industry.

Available in a myriad of shapes, textures and dazzling colors, Endicott products are nationally recognized for their unmatched elegance and design versatility. Endicott has the raw materials and manufacturing facilities to fire the finest architectural products. You have the imagination. A partnership is in the making.



**South Dakota State University** – Brookings, South Dakota  
 Special Blend; Thin Brick Precast; 1/2" x 2-1/4" x 7-5/8"; Wirecut Texture

Meets or exceeds the requirements of ASTM-C1088 specifications.

## THIN BRICK

Endicott thin brick is ideally suited to year-round commercial, residential and remodeling applications. Genuine kiln-fired thin brick possesses the durability and unparalleled elegance of Endicott face brick, yet maximizes space and weighs considerably less.

There are a number of prefabricated panel systems available to the industry that can receive the thin brick

as factory or job site applied. Reputable installation suppliers have literature that you may obtain for review regarding project applicability.

Endicott thin brick may be applied over any structurally sound substrate. And because no footings or supports are required, thin brick may extend all the way to grade.

## SIZES & TRIM UNITS



Endicott's unique "keyback" design mechanically locks thin brick into the concrete for maximum durability and permanence.

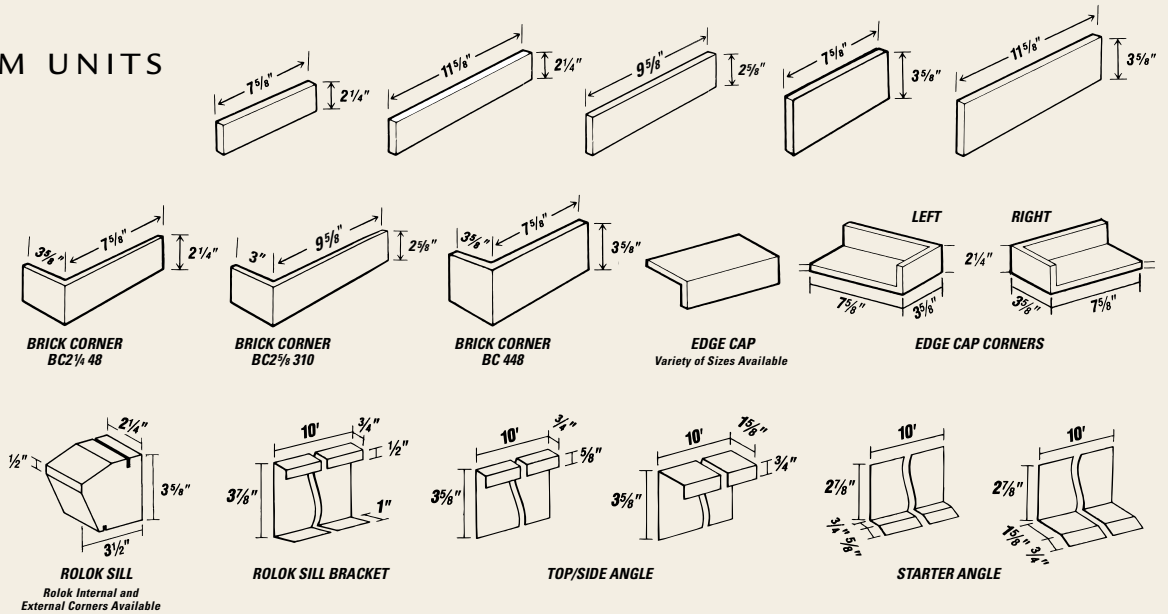

## TEXTURES

SHOWN HERE

NOT SHOWN HERE, BUT AVAILABLE

Heritage Smooth  
 Velour Wirecut

Stonetex

# THIN BRICK COLORS

Endicott provides a wide variety of thin brick colors, textures and sizes. Contact us for a complete selection of products, or for your nearest distributor. You can also find selection information at [endicott.com](http://endicott.com).



**AUTUMN SANDS** – HERITAGE TEXTURE

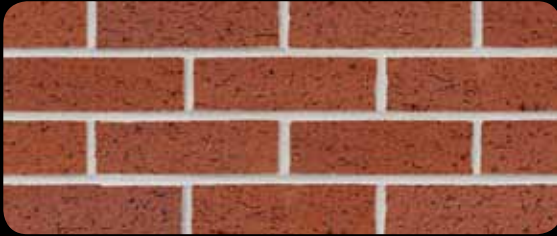

**RED BLEND** – VELOUR TEXTURE



**LIGHT SANDSTONE** – SMOOTH TEXTURE



**DESERT IRONSPOT LIGHT** – VELOUR TEXTURE



**EXECUTIVE IRONSPOT** – SMOOTH TEXTURE



**BURGUNDY SANDS** – HERITAGE TEXTURE



**GOLDEN BUFF** – WIRECUT TEXTURE



**COPPERTONE** – VELOUR TEXTURE



**GREY BLEND** – VELOUR TEXTURE



**MEDIUM IRONSPOT #46** – WIRECUT TEXTURE



**MANGANESE IRONSPOT** – WIRECUT TEXTURE

# TILE

Endicott's line of tile products is manufactured utilizing the same raw materials as thin brick, face brick and pavers. Thus, product coordination provides excellent design flexibility. The tile and trim units pictured below are available in a variety of colors and these textures – Smooth, Wirecut and Stonetex.

## SIZES & SPECIFICATIONS

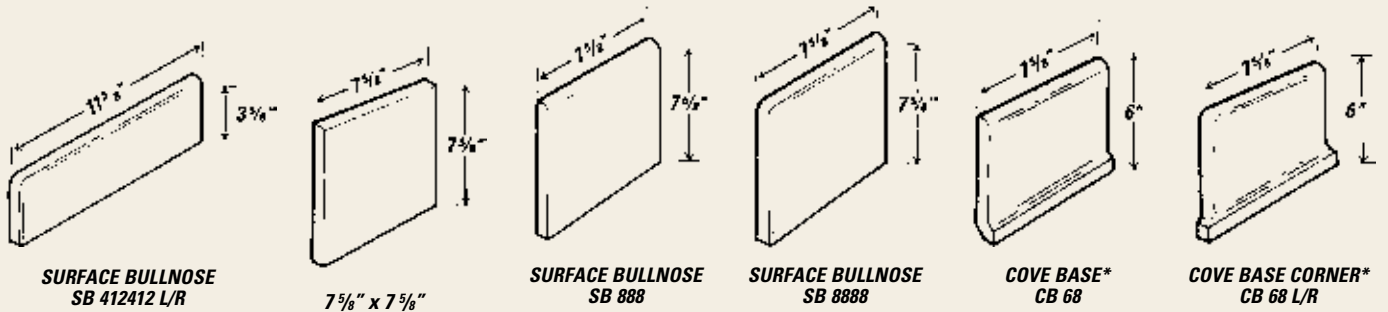
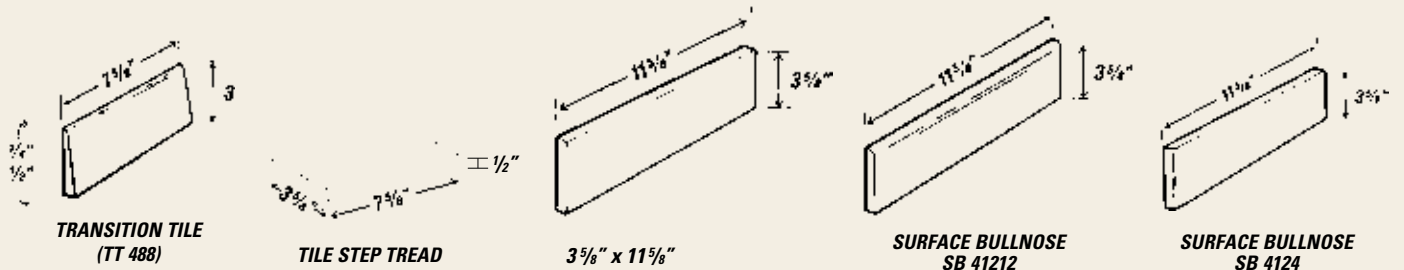
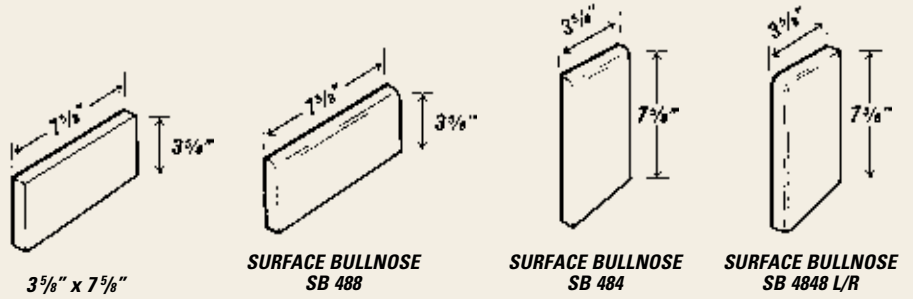

\*Cove Base units are available in smooth texture only.



**Office Plaza** – Pittsburgh, Pennsylvania  
Coppertone Smooth – 1/2" x 3-5/8" x 7-5/8"



**Fashion Valley Mall** – San Diego, California  
Rose Blend Wirecut – 1/2" x 3-5/8" x 7-5/8"  
and Dark Ironspot Wirecut – 1/2" x 3-5/8" x 7-5/8"

# TILE COLORS (ALL SAMPLES SHOWN HERE ARE SMOOTH TEXTURE)



COPPERTONE



MEDIUM IRONSPOT #77



MEDIUM IRONSPOT #46



DESERT IRONSPOT



MANGANESE IRONSPOT



RED BLEND



ROSE BLEND



DARK IRONSPOT

## TILE TEXTURES AVAILABLE\*



SMOOTH TEXTURE

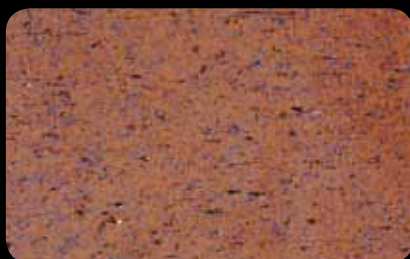

WIRECUT TEXTURE



STONETEX TEXTURE



# FACE BRICK

Endicott has a face brick to meet most any design criteria. A variety of colors, including authentic Ironspots and a wide selection of textures and sizes, provides the designer with an array of product selections.

## SIZES & SPECIFICATIONS



**MODULAR**

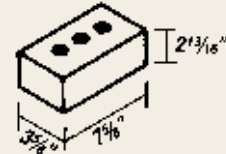

**ENGINEER MODULAR**

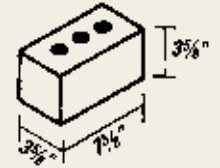

**CLOSURE  
(Economy Modular)**

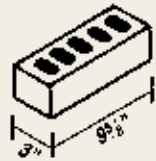

**KINGSIZE**

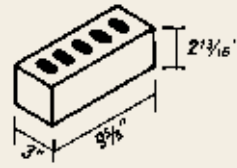

**ENGINEER KINGSIZE**

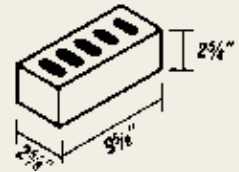

**SLIMKING**

**University of Pennsylvania, Wharton School of Business –**  
Philadelphia, Pennsylvania  
Burgundy Blend; Normans - Shapes; Smooth Texture

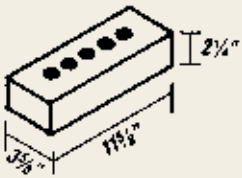

**NORMAN**

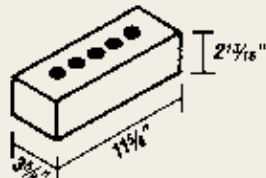

**NORWEGIAN  
(Engineer Norman)**

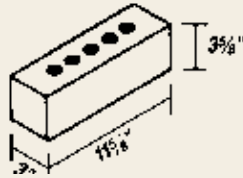

**3" UTILITY  
(3" Bed Economy Norman)**

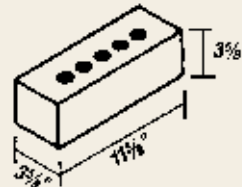

**UTILITY  
(Economy Norman)**

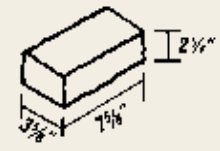

**DANISH  
HAND MOULD**

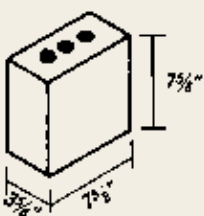

**TRIPLE BRICK**

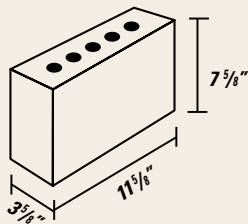

**DOUBLE UTILITY**

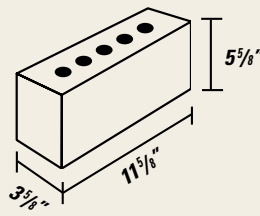

**GIANT NORMAN**

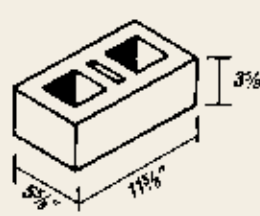

**6" THRU WALL UNIT**

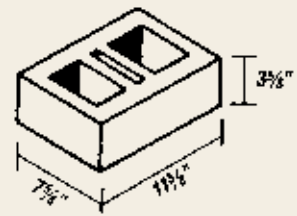

**8" THRU WALL UNIT**

## TEXTURES

### SHOWN HERE

- Antique
- Heritage
- Velour
- Artisan
- Smooth
- Velvetex

### NOT SHOWN HERE, BUT AVAILABLE

- Danish Hand Mould
- Matt
- Vertical Score

# FACE BRICK COLORS

Endicott provides a wide variety of face brick colors, textures and sizes. Contact us for a complete selection of products, or for your nearest distributor. You can also find selection information at [endicott.com](http://endicott.com).



**MANGANESE IRONSPOT** – SMOOTH TEXTURE



**SAHARA SANDS** – HERITAGE TEXTURE



**COPPERTONE** – VELOUR TEXTURE



**MEDIUM IRONSPOT #77** – ARTISAN TEXTURE



**MERLOT SANDS** – ANTIQUE TEXTURE



**EXECUTIVE IRONSPOT** – VELOUR TEXTURE



**AUTUMN SANDS** – HERITAGE TEXTURE



**DESERT IRONSPOT (LIGHT)** – VELOUR TEXTURE



**DARK IRONSPOT** – SMOOTH TEXTURE



**BURGUNDY SANDS** – HERITAGE TEXTURE



**MEDIUM IRONSPOT #46** – VELVETEX TEXTURE



**Private Residence** – Omaha, Nebraska  
Medium Ironspot #77; Artisan Modular

## RESIDENTIAL BRICK

Available in a myriad of colors, enhanced by a choice of accent textures, Endicott brick graces many outstanding residential projects throughout the United States.



**Private Residence** – Lincoln, Nebraska  
Grey Heritage; Modular

**Private Residence** – Lincoln, Nebraska  
Burgundy Sands; Heritage Texture





**All Saints Catholic Church** – Lakeville, Minnesota  
Desert Ironspot Light; Utility - Shapes; Velour Texture



## SPECIAL SHAPES

Regardless of what's perceived in the mind's eye, Endicott possesses the ability to transform that image into an aesthetically beautiful shape of the highest quality. These shapes, available in colors, textures and sizes to match the face brick, create the benchmark for design flexibility.



**Creekside Middle School** – Carmel, Indiana  
Medium Ironspot #46; Golden Buff;  
Modular - Triple Brick - Shapes; Velour Texture



# PAVERS

Endicott's complete line of brick pavers gracefully enhances any landscape setting and coordinates with Endicott's face brick, tile and pool coping.

Endicott's relieved edge pavers feature beveled edges that make a unique visual presentation. The pavers are set hand-tight or butt joint. Beveled edges create a spaced joint effect, yet are not grouted. Small spacings (1/16"-1/8") between units accommodate sand sweepings to keep the units apart and create interlock. They're manufactured to meet ASTM C902, Class SX, Type I, Application PX or ASTM C1272, Type R, Application PX specifications.



**Independence Grove Forest Preserve** – Libertyville, Illinois  
Custom blend of paver colors and sizes

## SIZES & SPECIFICATIONS

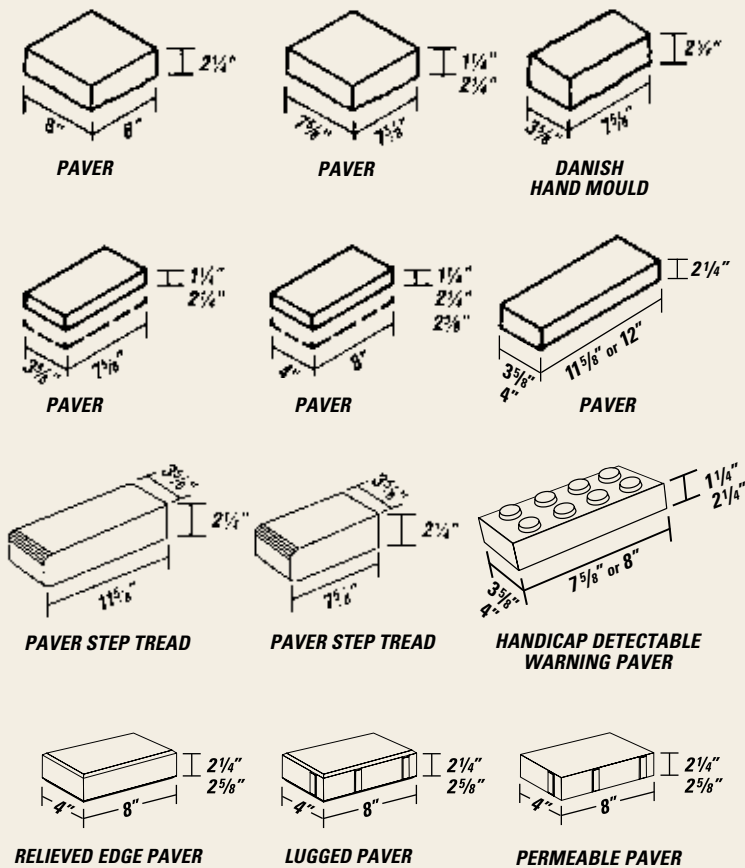

## PAVER SPACERS

ELIMINATE PAVER CHIPPING PROBLEMS

Create and assure the needed spacing between pavers to avoid expensive and unsightly chipping. Keep the crisp appearance of square edge pavers!



Paver Spacers used in a Herringbone pattern

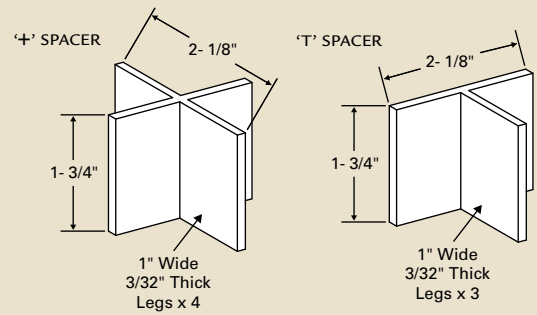

### Handicap Detectable Warning pavers

Consult the American Disabilities Act of 1990 Accessibility Guidelines for exact requirements and usage.



# PAVERS (ALL PAVERS ARE WIRECUT TEXTURE)



**MANGANESE IRONSPOT**



**MEDIUM IRONSPOT #77**



**MEDIUM IRONSPOT #46**



**COPPERTONE**



**BORDEAUX BLEND**



**DARK IRONSPOT**



**ROSE BLEND (Shown as Handicap Detectable)**



**RED BLEND**

# POOL COPING

Applications for this unit are limited only by the imagination. In addition to swimming pools, other unique applications include step nosing and decorative accents on windows, fireplace mantels and hearths.

Pool coping units are available in colors to coordinate with Endicott pavers and tile.

## ESTIMATING DATA

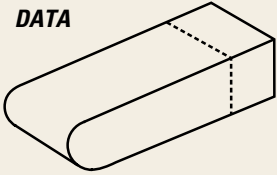

### POOL COPING:

*actual size* – 2 1/4" x 3 5/8" x 9"  
*metric size* – 57 x 92 x 228  
*weight per unit* – 6#  
*no. per linear ft.* – 3

*actual size* – 2 1/4" x 3 5/8" x 11 5/8"  
*metric size* – 57 x 92 x 295  
*weight per unit* – 7.5#  
*no. per linear ft.* – 3

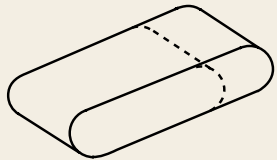

### POOL COPING DOUBLE BULLNOSE:

*actual size* – 2 1/4" x 3 5/8" x 9"  
*metric size* – 57 x 92 x 228  
*weight per unit* – 6#  
*no. per linear ft.* – 3

*actual size* – 2 1/4" x 3 5/8" x 11 5/8"  
*metric size* – 57 x 92 x 295  
*weight per unit* – 7.5#  
*no. per linear ft.* – 3

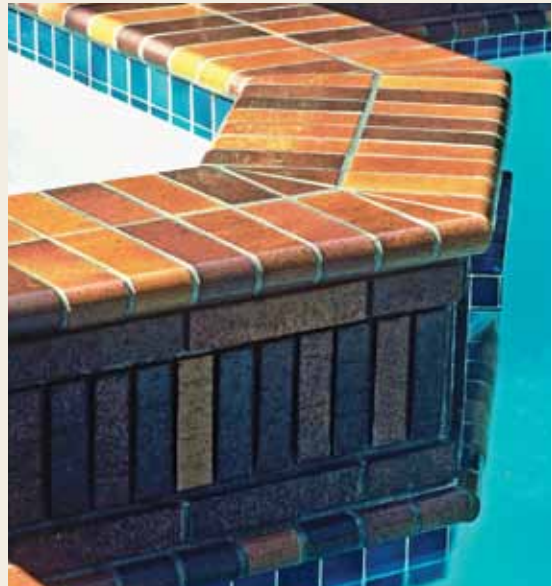

Private Residence – La Jolla, California



**First Community Bank** – Reedsburg, Wisconsin



**National Eagle Center** – Wabasha, Minnesota



**Private Residence** – Fairbury, Nebraska

## BRICK MURALS

Imagine the majesty of hand-crafted brick murals that capture the energetic vitality of life itself, all reproduced in authentic Ironspot colors that defy description. With visionary flair, Endicott continues to sculpt a reputation for producing works of art that are truly distinctive.



Endicott Clay Products Co and Endicott Tile LLC – Endicott, Nebraska



Endicott has been building one success story after another all across the U.S.

The unique clays found only in Jefferson County, Nebraska, make it possible for Endicott to produce a wide variety of face brick, pavers, tile, thin brick and special shapes that are nationally recognized for their quality and aesthetic beauty.

Endicott products are distributed throughout the United States. For literature, samples and the name of your nearest distributor, contact Endicott today.

Endicott Clay Products Co  
P.O. Box 17  
Fairbury, Nebraska USA 68352  
402/729-3315 FAX: 402/729-5804

Endicott Tile LLC  
P.O. Box 645  
Fairbury, Nebraska USA 68352  
402/729-3323 FAX: 402/729-5804

endicott@endicott.com  
endicott.com

*View Endicott Colors Now!*

